

KG1101-51 Assembly Board

2024. 05

■MR Sensor

Type	KG1101-51
------	-----------

■Pin Assignment

No.	Function
1	GND
2	-OUT
3	+OUT
4	VCC

■Board

Material	FR-4
Thickness	1.2mm
Electrode	Au

■Dimension

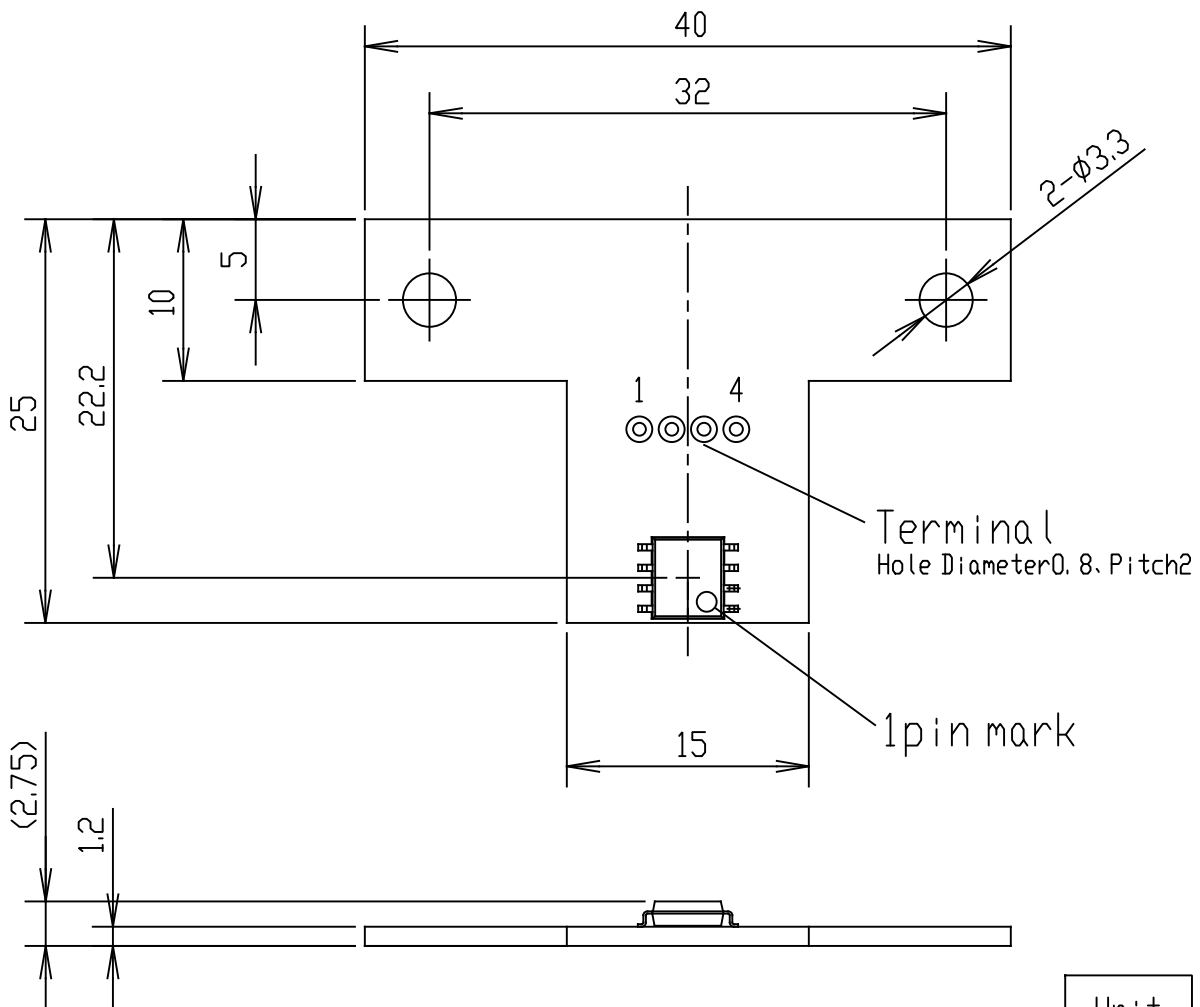

Unit
mm